

Kit 3029

MERCEDES Viano, 4-dr MPV, 04-
MERCEDES Vito, 4-dr VAN, 04-

This Kit is only for vehicles with fixpoint mounting.



460R
753



460

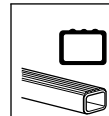

6 kg / 13 lbs + xx kg / xx lbs =

Max. 100 kg
Max. 220 lbs

9 kg / 20 lbs + xx kg / xx lbs =

Max. 150 kg
Max. 330 lbs

12 kg / 26 lbs + xx kg / xx lbs =

Max. 200 kg
Max. 440 lbs

Warning: Do not exceed the weight limits shown in the diagrams above.

THULE Kit XXXX

Warning: Read the instructions before use.

Warning: Do not exceed the recommended speed limits.

Speedometer limits:
80 km/h (50 Mph) - 130 km/h (80 Mph)
40 km/h (25 Mph)

A: Clean the roof surface with a brush and bucket.

B: Wipe the roof surface with a cloth.

C: Position the crossbar on the roof rails.

09 x 4

42 x 4

31356 x 8 (45 mm)

51345 x 8

RR, FR, FL, RL x 1

Kit



753

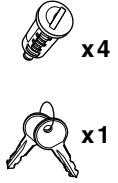
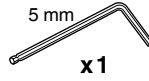
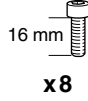
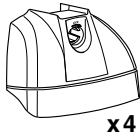
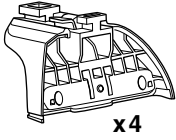

460R

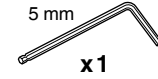
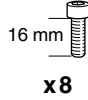
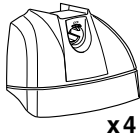
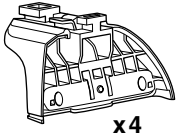

460

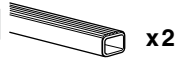
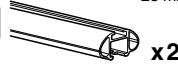
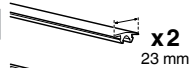
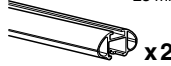
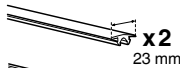
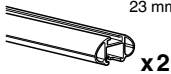
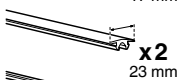
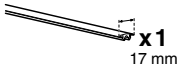
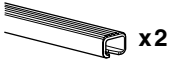
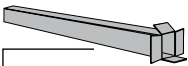
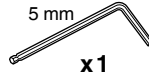
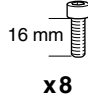
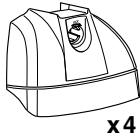
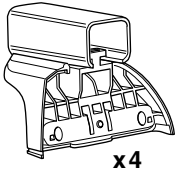

1

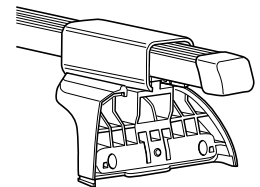
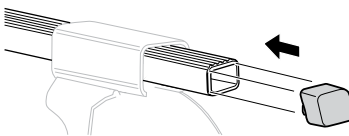
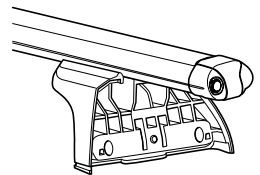
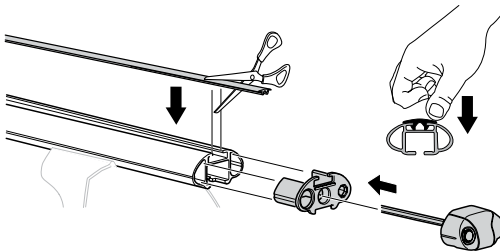
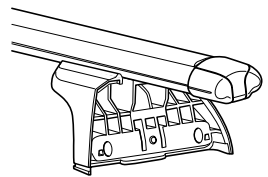
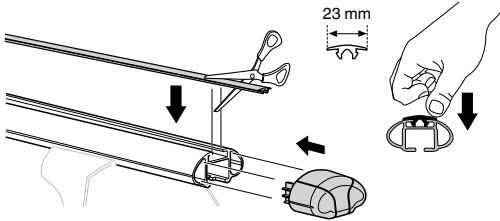
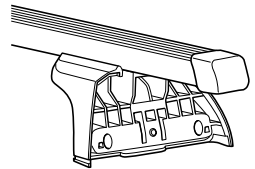
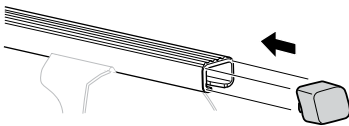
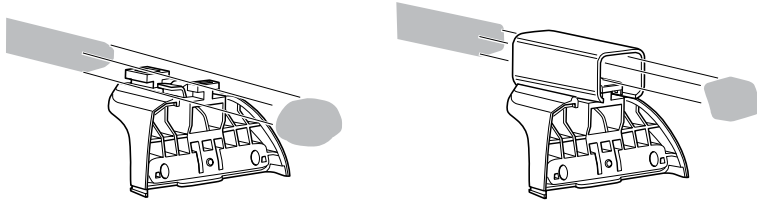
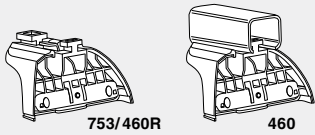

2

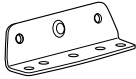

09 x 4

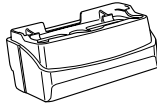

42 x 4



16 mm x 8



x 1

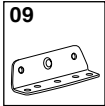

42

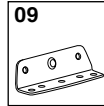
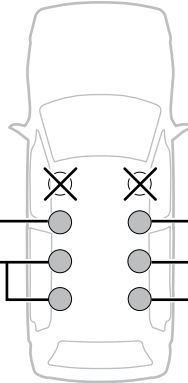

42

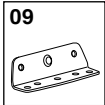
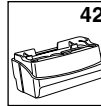

42

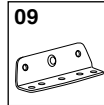

42

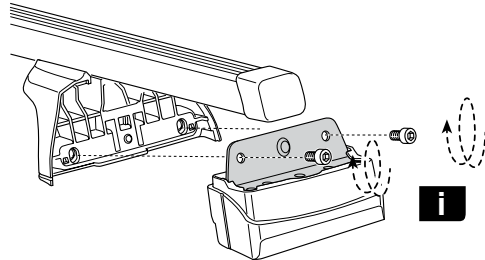
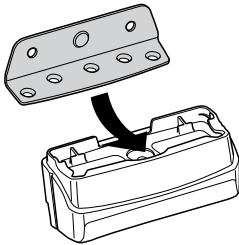
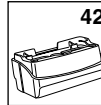

i

GB Only a few turns
D Nur wenige Umdrehungen
F Quelques tours uniquement
NL Slechts enkele slagen
I Solo qualche giro
E Sólo algunas vueltas
PT Noções básicas
S Endast några varv
FIN Vain muutama kierros

EST Ainult mõni pööre
LAT Tikai dažī apgriezieni
LIT Tik keli pasukimai
PL Wystarczy kilka obrotów
RU Достаточно нескольких оборотов
CZ Pouze několik otáček
SK Len niekoľko otáčok
SLO Le nekaj obratov

HR Samo nekoliko okreta
HU Csak néhány fordítás
GR Μόνο μερικές στροφές
TR Yalnız birkaç kez çevirm
中文 只有几个转向
한국어 두 세번만
日本語 数回転のみ
ไทย หมุนเพียงไม่กี่รอบ

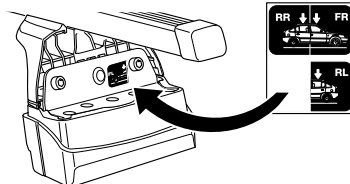

3

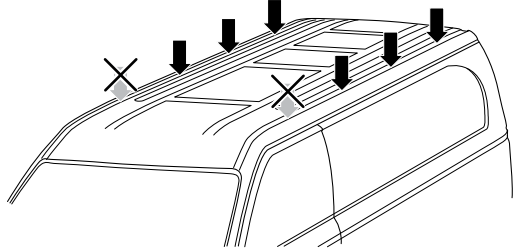
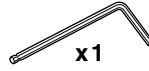

A

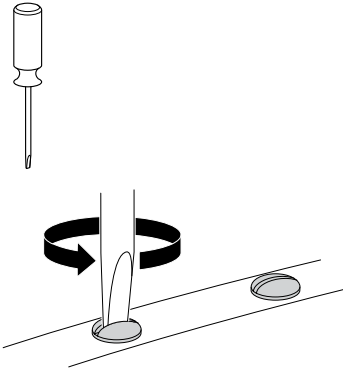

B

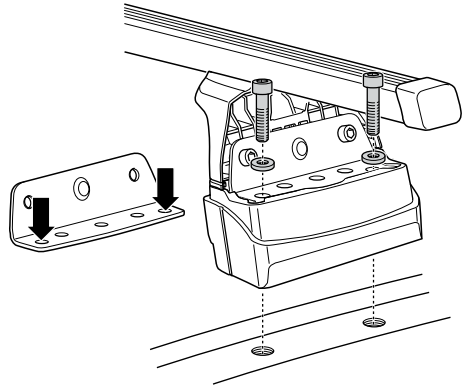

C

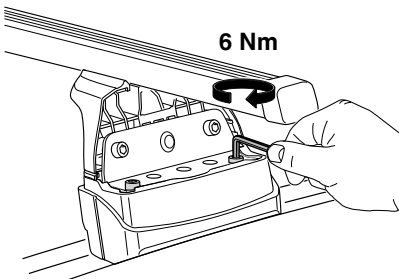

D

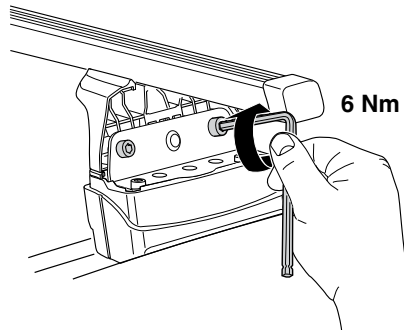

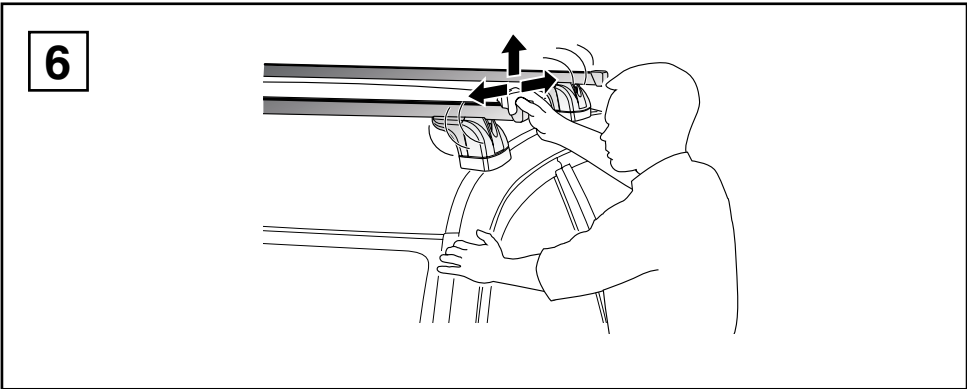
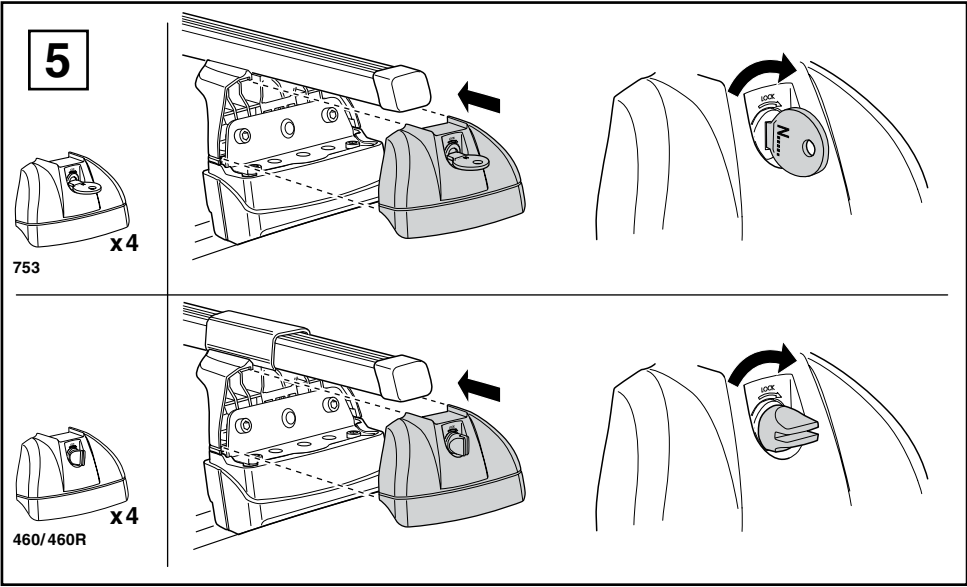
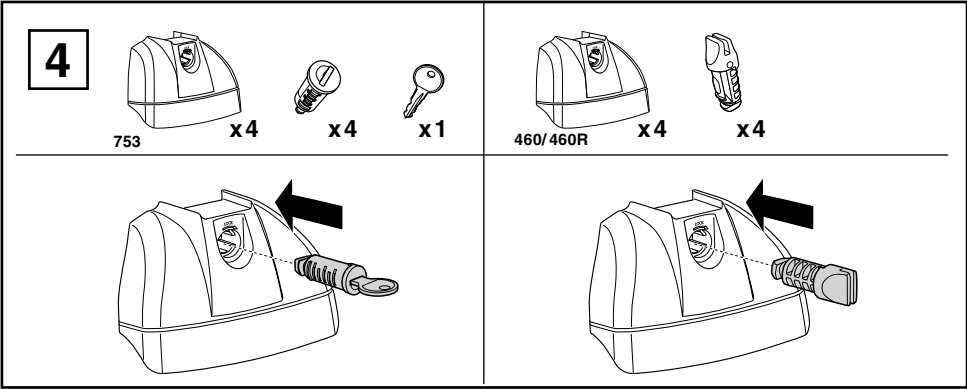

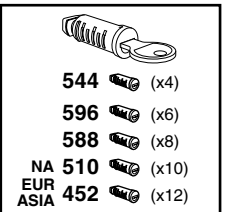
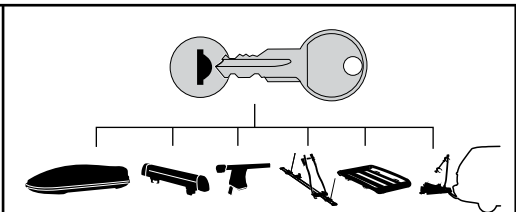
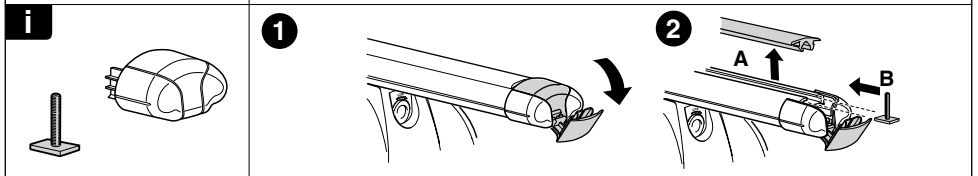
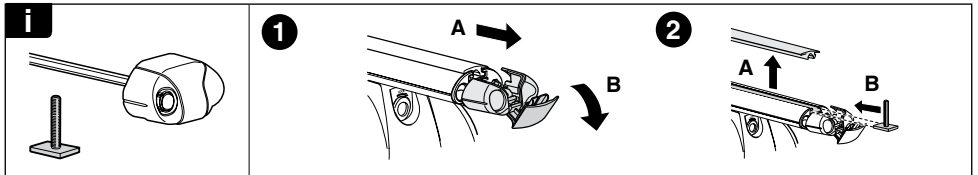
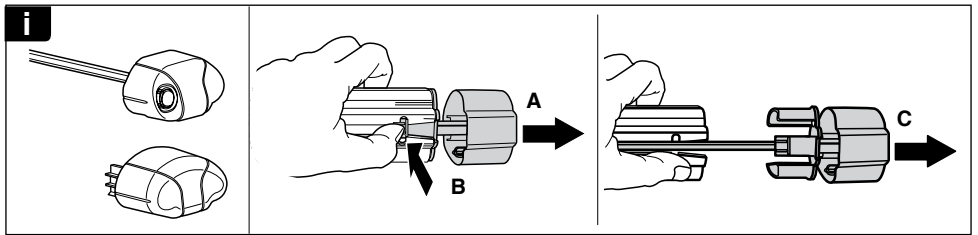
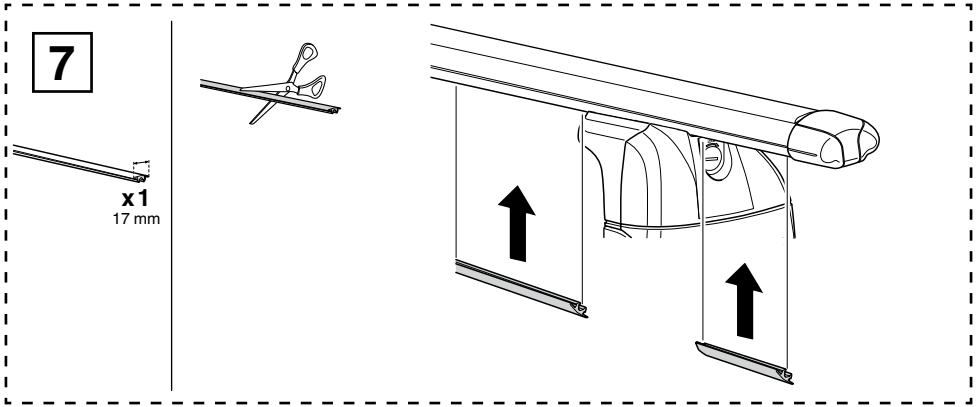

WW ▶ Thule Sweden AB, Box 69, 330 33 Hillerstorp, SWEDEN
NA ▶ Thule Inc., 42 Silvermine Road, Seymour, Connecticut 06483, USA

@ info@thule.com
 customer.service@thule.com

www.thule.com